

Pos.	Description	Material, Type	Size
1	Cover	PE / Cast iron	according to selection
2	Handrail, telescopic	AISI316	220x925
3	Service opening	PE	according to selection
4	Ladder, non slippery steps	AISI316	300x345
5	Air release valve	Steel	according to selection
6	Tank cylinder, double wall	PE100	ID2400, SN4
7	Gate valve AVK	Ductile iron	according to selection
8	Pressure pipe	PE100	according to selection
9	Bottom, steel reinforced	PE100 - Steel	120 mm
10	Anchor bolt W-FA	AISI316	M20x150, 16 pcs
11	Concrete plate, reinforced	Concrete	200x3200x3200
12	Backing rings	PP-Steel	according to selection
13	Bolts, nuts, washers	AISI316	M16

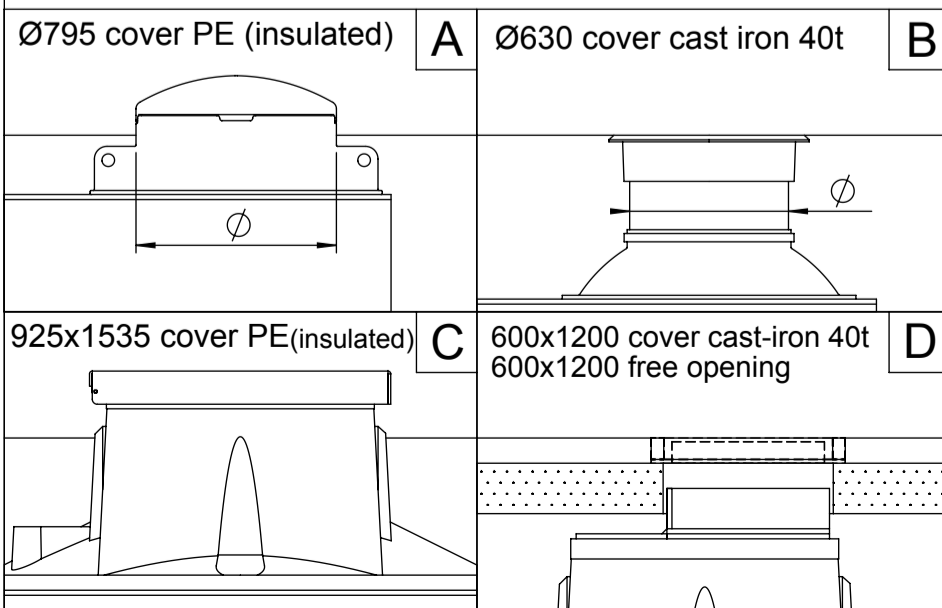

Service opening type	A	B	C	D
Handrail, telescopic (not available for type "B")	YES / NO			
Pressure pipe depth from Ground Surface	H = mm			
Pressure pipe diameter	D = mm			
Air release valve type	Potable water		Sewage	
Air release valve connection	DN50	DN80	DN100	DN150 DN200

Drawn:	A.Käärid	Air release well ID2400 STRONG		
Approved:	J.Karolin			
www.iwsgroup.ee		Mass: kg	Product code:	Rev.
Innovative Water Systems		NA	505230 / ordersheet	0