

EN 12566-1

KOMPLEKTI MÕÖDUD:

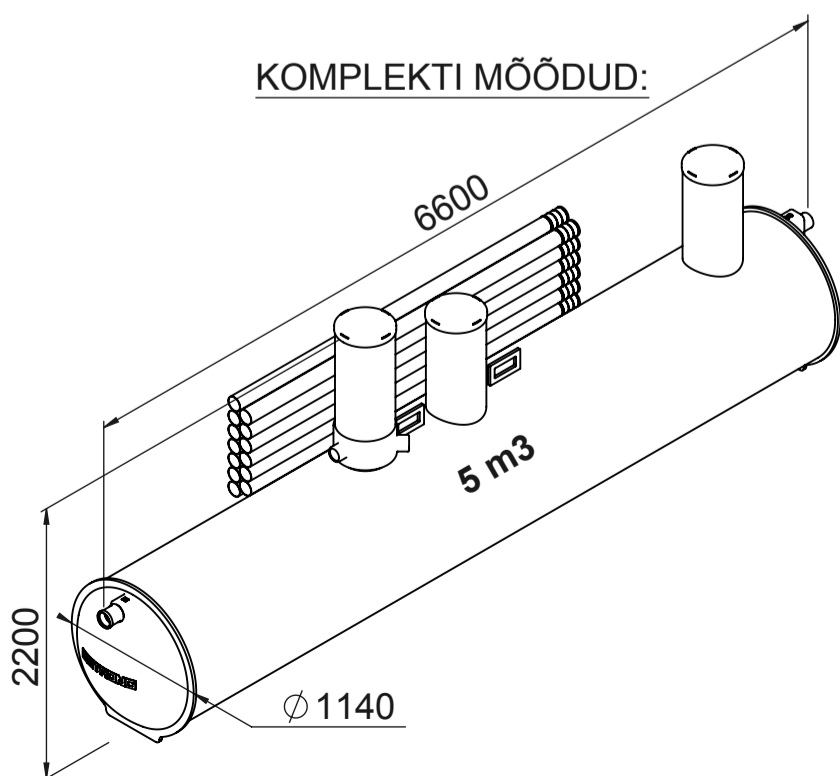

Pos.	Nimetus	Materjal	Mõõdud
1	Luuk	PVC	Ø400
2	Teenindusava	PE100	OD400, SN4, L800
3	Korpus	PE100	ID1000, SN2, L6000
4	Sissevoolu muhv	PVC	Ø110
5	Mahuti ots	PE	ID1000
6	Jaotuskaev	PE	Ø400
7	Jaotustoru	PP	Ø110, 3m, 2tk
8	Painduv käänik	PP	Ø110, 4tk
9	Imbtoru	PP	Ø110, 3m, 10tk
10	Tuulutustoru	PP	Ø110, 1.5m, 2tk
11	Tuulutusotsik	PVC	Ø110, 2tk
	Filterkangas	-	1.2x15m, 2tk

Joonistas:	A.Käärid	Septik ID1000 STRONG 5 m3		
Kinnitas:	J.Karolin			
www.iwsgroup.ee		Mass: kg	Tootekood:	Rev.
Innovative Water Systems		~370	501110	0